

# NTJD4105C

## Small Signal MOSFET

20 V / -8.0 V, Complementary,  
+0.63 A / -0.775 A, SC-88

### Features

- Complementary N and P Channel Device
- Leading -8.0 V Trench for Low  $R_{DS(on)}$  Performance
- ESD Protected Gate – ESD Rating: Class 1
- SC-88 Package for Small Footprint (2 x 2 mm)
- Pb-Free Package May be Available. The G-Suffix Denotes a Pb-Free Lead Finish

### Applications

- DC-DC Conversion
- Load/Power Switching
- Single or Dual Cell Li-Ion Battery Supplied Devices
- Cell Phones, MP3s, Digital Cameras, PDAs

### MAXIMUM RATINGS ( $T_J = 25^\circ\text{C}$ unless otherwise noted)

Parameter	Symbol	Value	Unit	
Drain-to-Source Voltage	N-Ch	20	V	
	P-Ch	-8.0		
Gate-to-Source Voltage	N-Ch	$\pm 12$	V	
	P-Ch	$\pm 8.0$		
Continuous Drain Current – Steady State (Based on $R_{\theta JA}$ )	N-Ch	$T_A=25^\circ\text{C}$	0.63	A
		$T_A=85^\circ\text{C}$	0.46	
	P-Ch	$T_A=25^\circ\text{C}$	-0.775	
		$T_A=85^\circ\text{C}$	-0.558	
Continuous Drain Current – Steady State (Based on $R_{\theta JL}$ )	N-Ch	$T_A=25^\circ\text{C}$	0.91	
		$T_A=85^\circ\text{C}$	0.65	
	P-Ch	$T_A=25^\circ\text{C}$	-1.1	
		$T_A=85^\circ\text{C}$	-0.8	
Pulsed Drain Current	$t_p \leq 10 \mu\text{s}$	$I_{DM}$	$\pm 1.2$	A
Power Dissipation – Steady State (Based on $R_{\theta JA}$ )	$T_A=25^\circ\text{C}$	$P_D$	0.27	W
	$T_A=85^\circ\text{C}$		0.14	
Power Dissipation – Steady State (Based on $R_{\theta JL}$ )	$T_A=25^\circ\text{C}$		0.55	
	$T_A=85^\circ\text{C}$		0.29	
Operating Junction and Storage Temperature	$T_J, T_{STG}$	-55 to 150		$^\circ\text{C}$
Source Current (Body Diode)	N-Ch	$I_S$	0.63	A
	P-Ch		-0.775	
Lead Temperature for Soldering Purposes (1/8" from case for 10 s)	$T_L$	260		$^\circ\text{C}$

### THERMAL RESISTANCE RATINGS (Note 1)

Junction-to-Ambient – Steady State	Typ	$R_{\theta JA}$	400	$^\circ\text{C/W}$
	Max		460	
Junction-to-Lead (Drain) – Steady State	Typ	$R_{\theta JL}$	194	
	Max		226	

1. Surface mounted on FR4 board using 1 oz Cu area = 0.9523 in sq.



ON Semiconductor®

<http://onsemi.com>

$V_{(BR)DSS}$	$R_{DS(on)}$ TYP	$I_D$ MAX
N-Ch 20 V	0.29 $\Omega$ @ 4.5 V	0.63 A
	0.36 $\Omega$ @ 2.5 V	
P-Ch -8.0 V	0.22 $\Omega$ @ -4.5 V	-0.775 A
	0.32 $\Omega$ @ -2.5 V	
	0.51 $\Omega$ @ -1.8 V	

### SOT-363 SC-88 (6-LEADS)

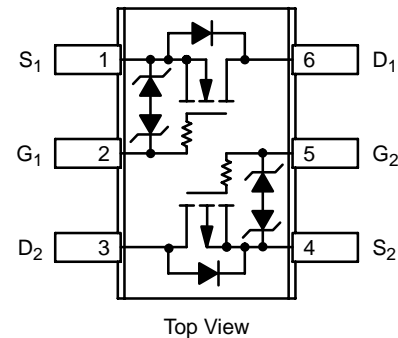

Top View



### SC-88 (SOT-363) CASE 419B Style 26

### MARKING DIAGRAM & PIN ASSIGNMENT

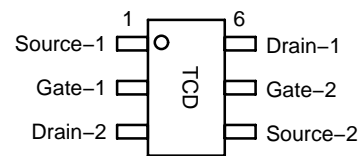

Top View

TC = Specific Device Code  
D = Date Code

### ORDERING INFORMATION

See detailed ordering and shipping information in the package dimensions section on page 7 of this data sheet.

# NTJD4105C

## ELECTRICAL CHARACTERISTICS (T<sub>J</sub> = 25°C unless otherwise noted)

Parameter	Symbol	N/P	Test Condition	Min	Typ	Max	Units
<b>OFF CHARACTERISTICS</b>							
Drain-to-Source Breakdown Voltage	V <sub>(BR)DSS</sub>	N	V <sub>GS</sub> =0 V	I <sub>D</sub> =250 μA	20	27	V
		P		I <sub>D</sub> =-250 μA	-8.0	-10.5	
Drain-to-Source Breakdown Voltage Temperature Coefficient	V <sub>(BR)DSS</sub> / T <sub>J</sub>	N			22		mV/°C
		P			-6.0		
Zero Gate Voltage Drain Current	I <sub>DSS</sub>	N	V <sub>GS</sub> =0 V, V <sub>DS</sub> =16 V	T <sub>J</sub> =25 °C		1.0	μA
		P	V <sub>GS</sub> =0 V, V <sub>DS</sub> =-6.4 V			1.0	
Gate-to-Source Leakage Current	I <sub>GSS</sub>	N	V <sub>DS</sub> =0 V	V <sub>GS</sub> =±12 V		10	μA
		P		V <sub>GS</sub> =±8.0		10	

## ON CHARACTERISTICS (Note 2)

Gate Threshold Voltage	V <sub>GS(TH)</sub>	N	V <sub>GS</sub> =V <sub>DS</sub>	I <sub>D</sub> =250 μA	0.6	0.92	1.5	V
		P		I <sub>D</sub> =-250 μA	-0.45	-0.83	-1.0	
Gate Threshold Temperature Coefficient	V <sub>GS(TH)</sub> / T <sub>J</sub>	N				-2.1		-mV/°C
		P				2.2		
Drain-to-Source On Resistance	R <sub>DS(on)</sub>	N	V <sub>GS</sub> =4.5 V, I <sub>D</sub> =0.63 A		0.29	0.375	Ω	
		P	V <sub>GS</sub> =-4.5 V, I <sub>D</sub> =-0.57 A		0.22	0.30		
		N	V <sub>GS</sub> =2.5 V, I <sub>D</sub> =0.40 A		0.36	0.445		
		P	V <sub>GS</sub> =-2.5 V, I <sub>D</sub> =-0.48 A		0.32	0.46		
		P	V <sub>GS</sub> =-1.8 V, I <sub>D</sub> =-0.20 A		0.51	0.90		
Forward Transconductance	g <sub>FS</sub>	N	V <sub>DS</sub> =4.0 V, I <sub>D</sub> =0.63 A		2.0		S	
		P	V <sub>DS</sub> =-4.0 V, I <sub>D</sub> =-0.57 A		2.0			

## CHARGES AND CAPACITANCES

Input Capacitance	C <sub>ISS</sub>	N	f=1 MHz, V <sub>GS</sub> =0 V	V <sub>DS</sub> =20 V	33	46	pF	
		P		V <sub>DS</sub> =-8.0V	160	225		
Output Capacitance	C <sub>OSS</sub>	N		V <sub>DS</sub> =20 V	13	22		
		P		V <sub>DS</sub> =-8.0 V	38	55		
Reverse Transfer Capacitance	C <sub>RSS</sub>	N		V <sub>DS</sub> =20 V	2.8	5.0		
		P		V <sub>DS</sub> =-8.0 V	28	40		
Total Gate Charge	Q <sub>G(TOT)</sub>	N		V <sub>GS</sub> =4.5 V, V <sub>DS</sub> =10 V, I <sub>D</sub> =0.7 A	1.3	3.0		nC
		P		V <sub>GS</sub> =-4.5 V, V <sub>DS</sub> =-5.0 V, I <sub>D</sub> =-0.6 A	2.2	4.0		
Threshold Gate Charge	Q <sub>G(TH)</sub>	N		V <sub>GS</sub> =4.5 V, V <sub>DS</sub> =10 V, I <sub>D</sub> =0.7 A	0.1			
		P		V <sub>GS</sub> =-4.5 V, V <sub>DS</sub> =-5.0 V, I <sub>D</sub> =-0.6 A	0.1			
Gate-to-Source Charge	Q <sub>GS</sub>	N	V <sub>GS</sub> =4.5 V, V <sub>DS</sub> =10 V, I <sub>D</sub> =0.7 A	0.2				
		P	V <sub>GS</sub> =-4.5 V, V <sub>DS</sub> =-5.0 V, I <sub>D</sub> =-0.6 A	0.5				
Gate-to-Drain Charge	Q <sub>GD</sub>	N	V <sub>GS</sub> =4.5 V, V <sub>DS</sub> =10 V, I <sub>D</sub> =0.7 A	0.4				
		P	V <sub>GS</sub> =-4.5 V, V <sub>DS</sub> =-5.0 V, I <sub>D</sub> =-0.6 A	0.5				

## SWITCHING CHARACTERISTICS (Note 3)

Turn-On Delay Time	t <sub>d(ON)</sub>	N	V <sub>GS</sub> =4.5 V, V <sub>DD</sub> =10 V, I <sub>D</sub> =0.5 A, R <sub>G</sub> =20 Ω	0.083		μs
Rise Time	t <sub>r</sub>			0.227		
Turn-Off Delay Time	t <sub>d(OFF)</sub>			0.786		
Fall Time	t <sub>f</sub>			0.506		
Turn-On Delay Time	t <sub>d(ON)</sub>	P	V <sub>GS</sub> =-4.5 V, V <sub>DD</sub> =-4.0 V, I <sub>D</sub> =-0.5 A, R <sub>G</sub> =8.0 Ω	0.013		
Rise Time	t <sub>r</sub>			0.023		
Turn-Off Delay Time	t <sub>d(OFF)</sub>			0.050		
Fall Time	t <sub>f</sub>			0.036		

## DRAIN-SOURCE DIODE CHARACTERISTICS

Forward Diode Voltage	V <sub>SD</sub>	N	V <sub>GS</sub> =0 V, T <sub>J</sub> =25°C	I <sub>S</sub> =0.23 A	0.76	1.1	V
		P		I <sub>S</sub> =-0.23 A	0.76	1.1	
		N	V <sub>GS</sub> =0 V, T <sub>J</sub> =125°C	I <sub>S</sub> =0.23 A	0.63		
		P		I <sub>S</sub> =-0.23 A	0.63		
Reverse Recovery Time	t <sub>RR</sub>	N	V <sub>GS</sub> =0 V, dI <sub>S</sub> /dt=90 A/μs	I <sub>S</sub> =0.23 A	0.410		μs
		P		I <sub>S</sub> =-0.23 A	0.078		

2. Pulse Test: pulse width ≤ 300 μs, duty cycle ≤ 2%.

3. Switching characteristics are independent of operating junction temperatures.

# NTJD4105C

## TYPICAL N-CHANNEL PERFORMANCE CURVES ( $T_J = 25^\circ\text{C}$ unless otherwise noted)

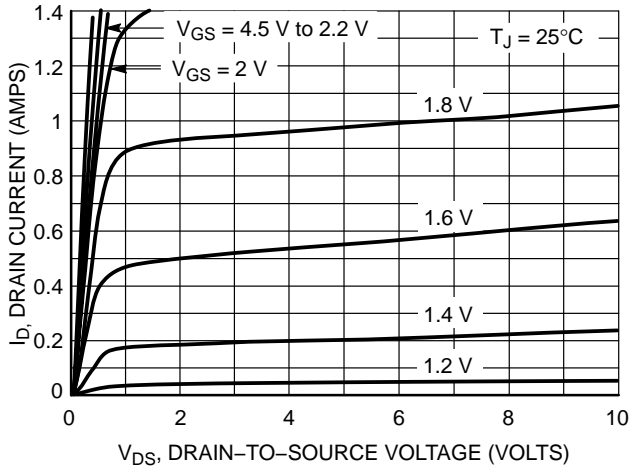

**Figure 1. On-Region Characteristics**

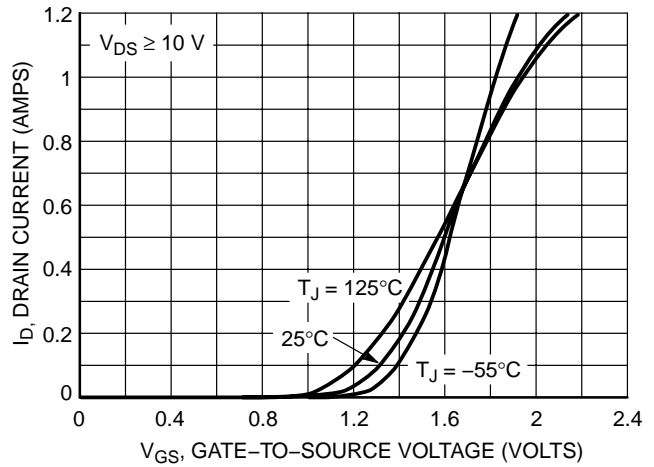

**Figure 2. Transfer Characteristics**

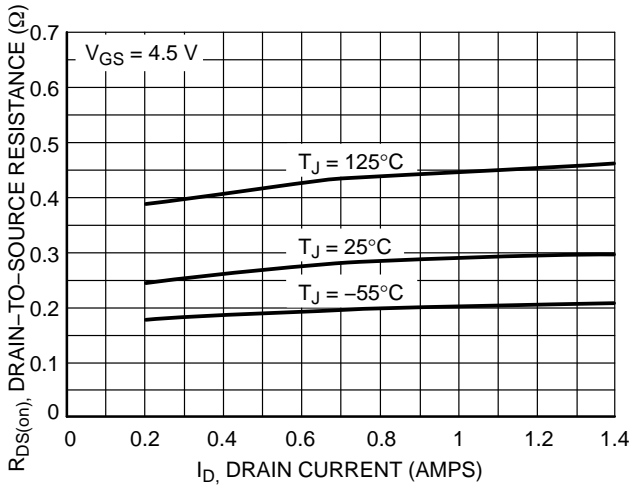

**Figure 3. On-Resistance vs. Drain Current and Temperature**

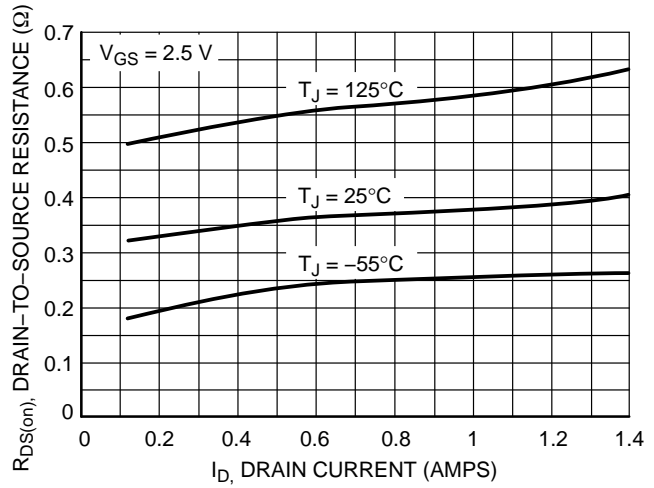

**Figure 4. On-Resistance vs. Drain Current and Temperature**

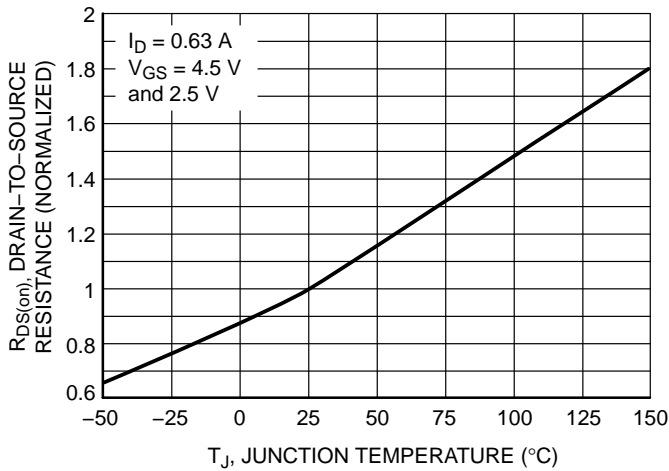

**Figure 5. On-Resistance Variation with Temperature**

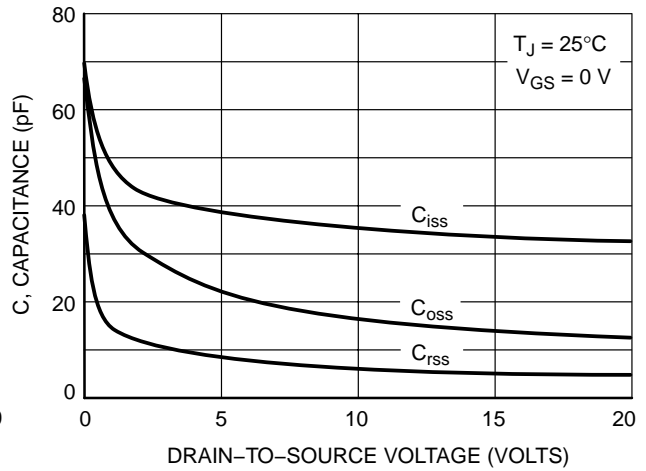

**Figure 6. Capacitance Variation**

# NTJD4105C

## TYPICAL N-CHANNEL PERFORMANCE CURVES ( $T_J = 25^\circ\text{C}$ unless otherwise noted)

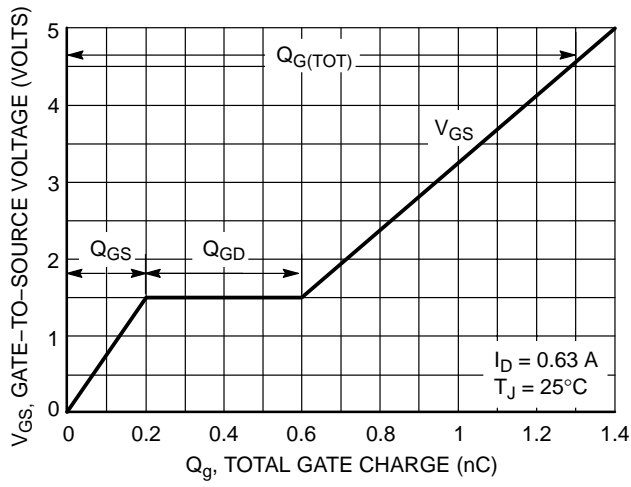

**Figure 7. Gate-to-Source and Drain-to-Source Voltage vs. Total Charge**

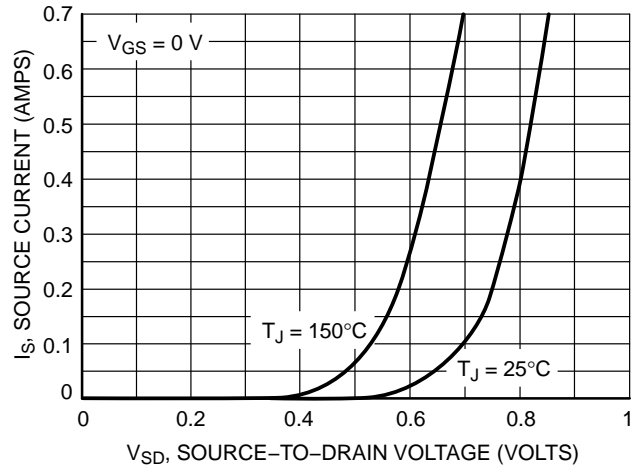

**Figure 8. Diode Forward Voltage vs. Current**

TYPICAL P-CHANNEL PERFORMANCE CURVES ( $T_J = 25^\circ\text{C}$  unless otherwise noted)

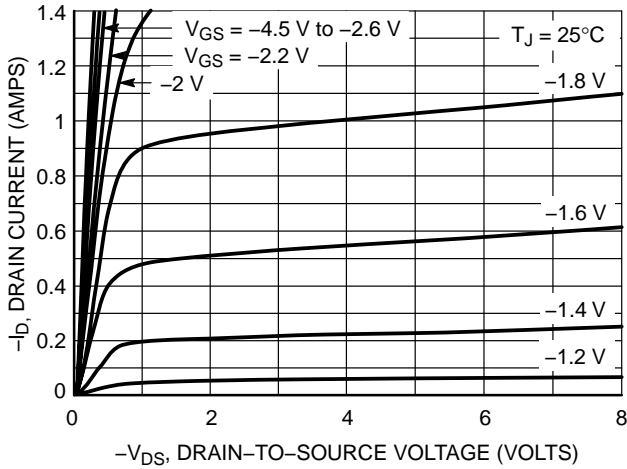

Figure 9. On-Region Characteristics

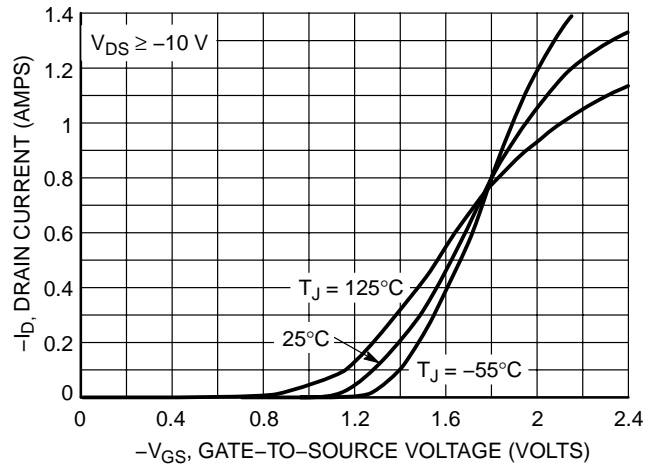

Figure 10. Transfer Characteristics

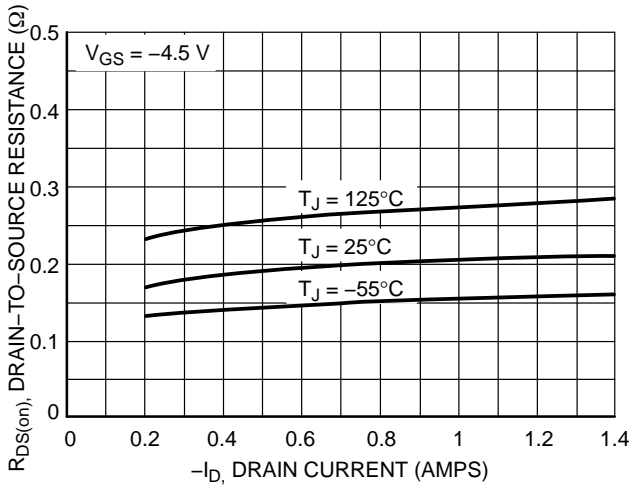

Figure 11. On-Resistance vs. Drain Current and Temperature

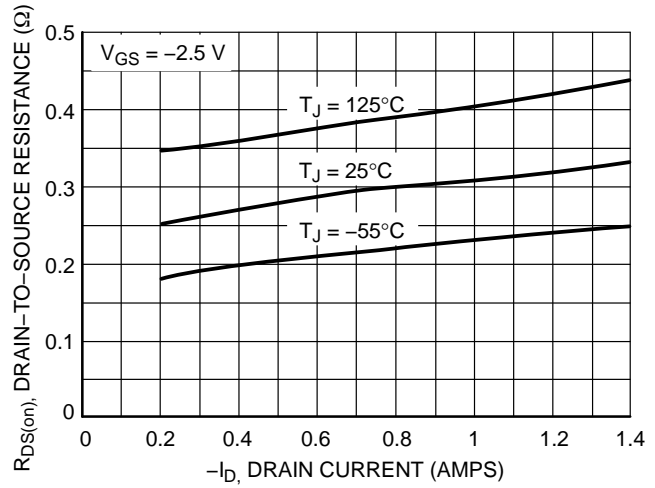

Figure 12. On-Resistance vs. Drain Current and Temperature

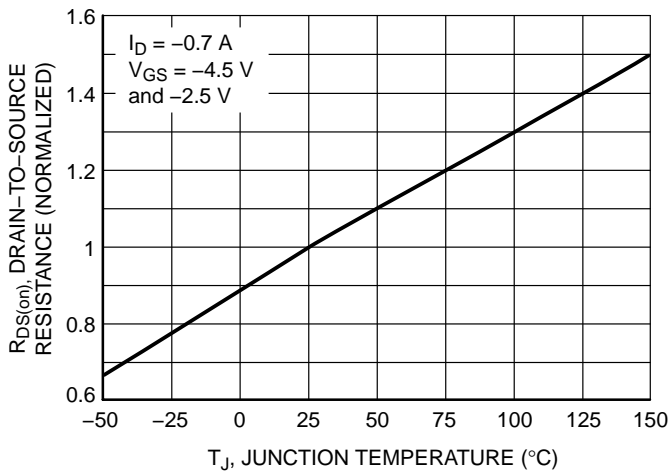

Figure 13. On-Resistance Variation with Temperature

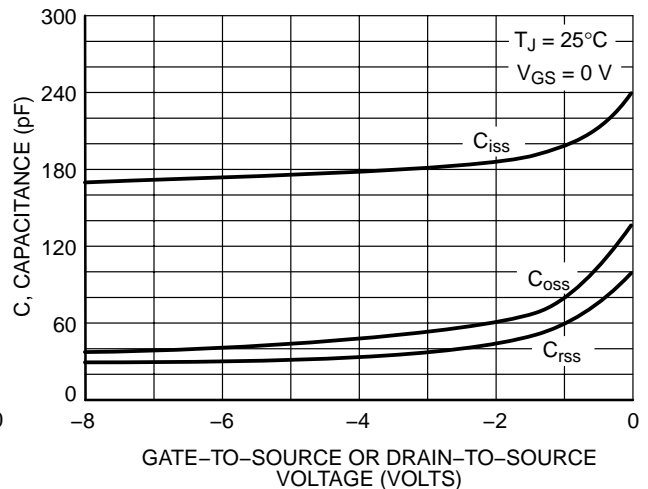

Figure 14. Capacitance Variation

# NTJD4105C

## TYPICAL P-CHANNEL PERFORMANCE CURVES ( $T_J = 25^\circ\text{C}$ unless otherwise noted)

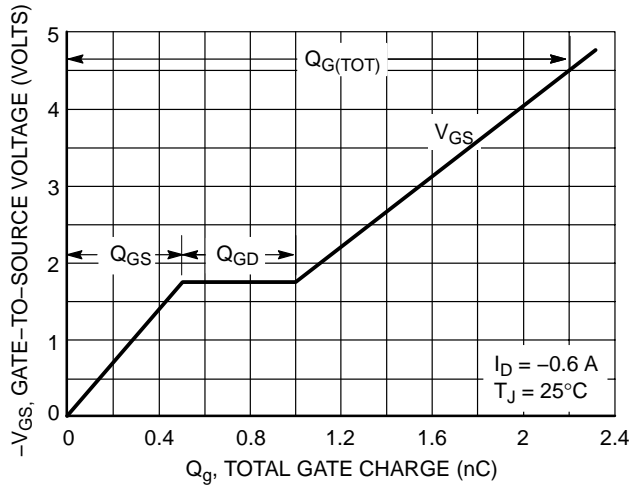

Figure 15. Gate-to-Source and Drain-to-Source Voltage vs. Total Charge

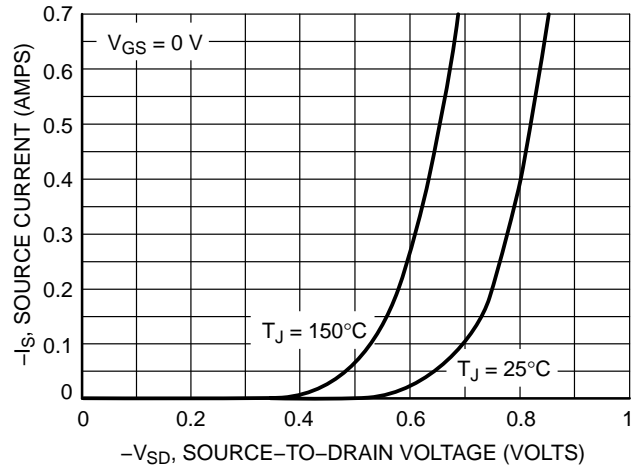

Figure 16. Diode Forward Voltage vs. Current

# NTJD4105C

## ORDERING INFORMATION1

Device	Package	Shipping†
NTJD4105CT1	SOT-363	3000 / Tape & Reel
NTJD4105CT1G	SOT-363 (Pb-Free)	3000 / Tape & Reel
NTJD4105CT2	SOT-363	3000 / Tape & Reel
NTJD4105CT2G	SOT-363 (Pb-Free)	3000 / Tape & Reel
NTJD4105CT4	SOT-363	10,000 / Tape & Reel
NTJD4105CT4G	SOT-363 (Pb-Free)	10,000 / Tape & Reel

†For information on tape and reel specifications, including part orientation and tape sizes, please refer to our Tape and Reel Packaging Specifications Brochure, BRD8011/D.

# NTJD4105C

## PACKAGE DIMENSIONS

### SC-88 (SOT-363) CASE 419B-02 ISSUE T

- NOTES:
1. DIMENSIONING AND TOLERANCING PER ANSI Y14.5M, 1982.
  2. CONTROLLING DIMENSION: INCH.
  3. 419B-01 OBSOLETE, NEW STANDARD 419B-02.

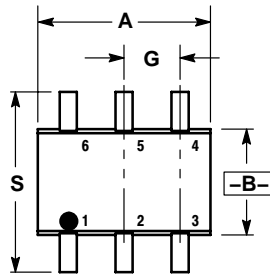

D 6 PL

⊕ 0.2 (0.008) M B M

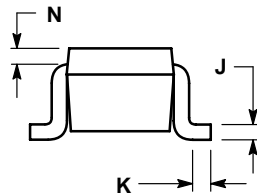
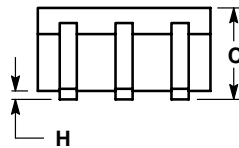

DIM	INCHES		MILLIMETERS	
	MIN	MAX	MIN	MAX
A	0.071	0.087	1.80	2.20
B	0.045	0.053	1.15	1.35
C	0.031	0.043	0.80	1.10
D	0.004	0.012	0.10	0.30
G	0.026 BSC		0.65 BSC	
H	---	0.004	---	0.10
J	0.004	0.010	0.10	0.25
K	0.004	0.012	0.10	0.30
N	0.008 REF		0.20 REF	
S	0.079	0.087	2.00	2.20

STYLE 26:

- PIN 1. SOURCE 1  
2. GATE 1  
3. DRAIN 2  
4. SOURCE 2  
5. GATE 2  
6. DRAIN 1

### SOLDERING FOOTPRINT\*

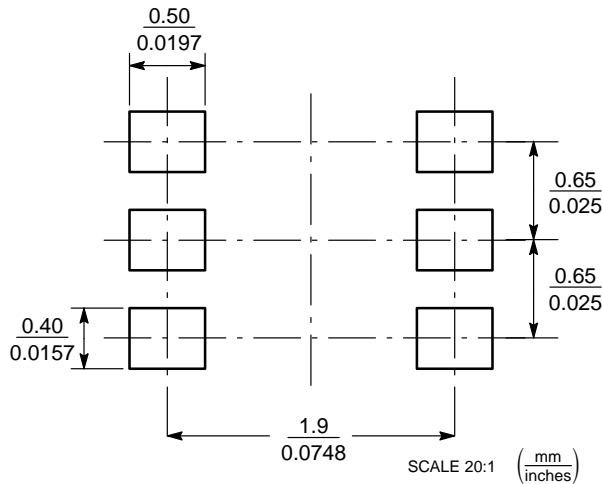

### SC-88/SC70-6

\*For additional information on our Pb-Free strategy and soldering details, please download the ON Semiconductor Soldering and Mounting Techniques Reference Manual, SOLDERRM/D.

ON Semiconductor and are registered trademarks of Semiconductor Components Industries, LLC (SCILLC). SCILLC reserves the right to make changes without further notice to any products herein. SCILLC makes no warranty, representation or guarantee regarding the suitability of its products for any particular purpose, nor does SCILLC assume any liability arising out of the application or use of any product or circuit, and specifically disclaims any and all liability, including without limitation special, consequential or incidental damages. "Typical" parameters which may be provided in SCILLC data sheets and/or specifications can and do vary in different applications and actual performance may vary over time. All operating parameters, including "Typicals" must be validated for each customer application by customer's technical experts. SCILLC does not convey any license under its patent rights nor the rights of others. SCILLC products are not designed, intended, or authorized for use as components in systems intended for surgical implant into the body, or other applications intended to support or sustain life, or for any other application in which the failure of the SCILLC product could create a situation where personal injury or death may occur. Should Buyer purchase or use SCILLC products for any such unintended or unauthorized application, Buyer shall indemnify and hold SCILLC and its officers, employees, subsidiaries, affiliates, and distributors harmless against all claims, costs, damages, and expenses, and reasonable attorney fees arising out of, directly or indirectly, any claim of personal injury or death associated with such unintended or unauthorized use, even if such claim alleges that SCILLC was negligent regarding the design or manufacture of the part. SCILLC is an Equal Opportunity/Affirmative Action Employer. This literature is subject to all applicable copyright laws and is not for resale in any manner.

### PUBLICATION ORDERING INFORMATION

**LITERATURE FULFILLMENT:**  
Literature Distribution Center for ON Semiconductor  
P.O. Box 5163, Denver, Colorado 80217 USA  
**Phone:** 303-675-2175 or 800-344-3860 Toll Free USA/Canada  
**Fax:** 303-675-2176 or 800-344-3867 Toll Free USA/Canada  
**Email:** orderlit@onsemi.com

**N. American Technical Support:** 800-282-9855 Toll Free  
USA/Canada

**Japan:** ON Semiconductor, Japan Customer Focus Center  
2-9-1 Kamimeguro, Meguro-ku, Tokyo, Japan 153-0051  
**Phone:** 81-3-5773-3850

**ON Semiconductor Website:** <http://onsemi.com>

**Order Literature:** <http://www.onsemi.com/litorder>

For additional information, please contact your local Sales Representative.